

# CONVEYOR ADJUSTABLE VACUUM GENERATORS



## Working principle

These vacuum generators operate based on the Venturi principle.

Unlike those previously described, the ejectors with which they are supplied are adjustable, in addition to having a considerably higher flow diameter.

This detail lets them vary the flow rate and level of vacuum of the device, without altering the level of vacuum of the supply air.

The compressed air consumption is also related to the actual performance of the vacuum generator.

## Features

The special shape of these adjustable vacuum generators, as well as their straight-flow working principle allow sucking and transferring products of various nature with no interference, just like flow generators, only, unlike these, they allow overcoming much higher level differences.

They are suited for transferring powders, granulated products, sawdust, metal chips, dry or liquid food products, etc. They are also recommended for controlling vacuum cups in presence of large amounts of dust or liquids, as well as for sucking fumes, cooling mists, water and oil condensation, etc. The absence of moving parts allows for a continuous use without developing heat.

The noise level, which is quite high for this kind of equipment, can be considerably reduced with a silencer screwed on the exhaust connection.

They do not require electricity, therefore, they can even be used in work environments with hazardous environments where an ignition source would be dangerous.

Available in anodised aluminium and stainless steel.

Thanks to all these features, a good filtration of the compressed air supply will be sufficient to make these devices fully maintenance-free.

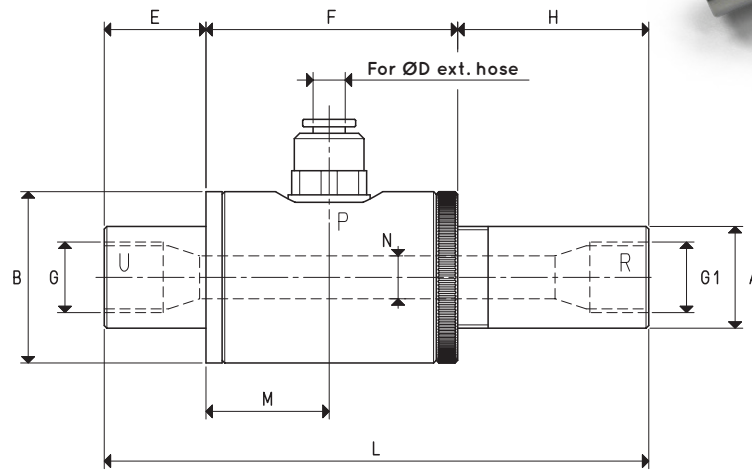

P=COMPRESSED AIR CONNECTION

R=EXHAUST

U=VACUUM CONNECTION

Item		PVR 25	PVR 50
Max quantity of intake air at 5 bar	m <sup>3</sup> /h	13.0	36.0
Max quantity of air blown at 6 bar	m <sup>3</sup> /h	33.5	88.0
Maximum level of vacuum	-KPa	80	75
Final pressure	abs. mbar	200	250
Maximum supply pressure	bar	6	6
Maximum air consumption at 6 bar	NI/s	6.1	15.5
Temperature of use	°C	-20 / +80	-20 / +80
Noise level	dB(A)	92	98
Weight	g	150	280
A	∅	19	26
B	∅	32	38
D	∅	6	8
E		19	35
F		47	54
G	∅	G1/4"	G3/8"
G 1	∅	G1/4"	G1/2"
H		34	61
L		100	150
M		22	25
N	∅	6	10

Note: All vacuum values indicated in the table are valid at the normal atmospheric pressure of 1013 mbar and obtained with a constant supply pressure.

Add the letter I, to the item for a generator supplied in stainless steel (Example: PVR 50 I).

Vacuum generator supply must be carried out with non-lubricated compressed air, 5 micron filtration, in accordance with standard ISO 8573-1 class 4.

Transformation ratio: N (newton) = Kg x 9.81 (force of gravity)

inch =  $\frac{\text{mm}}{25.4}$ ; pounds =  $\frac{\text{g}}{453.6} = \frac{\text{Kg}}{0.4536}$

Adapters for GAS - NPT threading available on page 1.130



# ADJUSTABLE CONVEYOR VACUUM GENERATORS PVR 25 and PVR 50

Quantity of air suctioned ( $m^3/h$ ) at different supply pressures (bar)

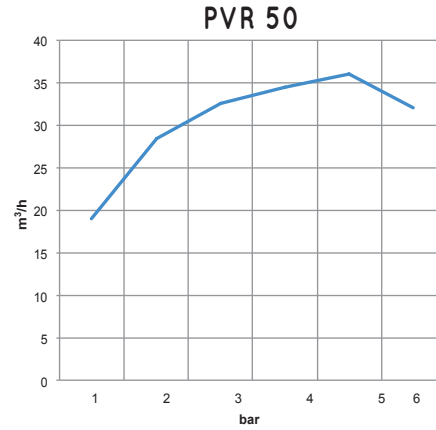
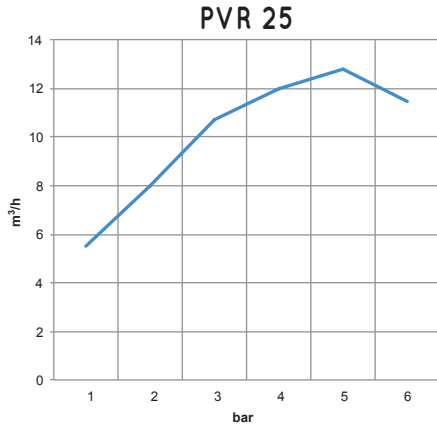

Quantity of air blown ( $m^3/h$ ) at different supply pressures (bar)

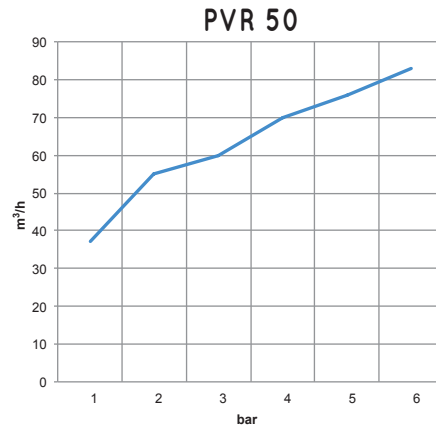
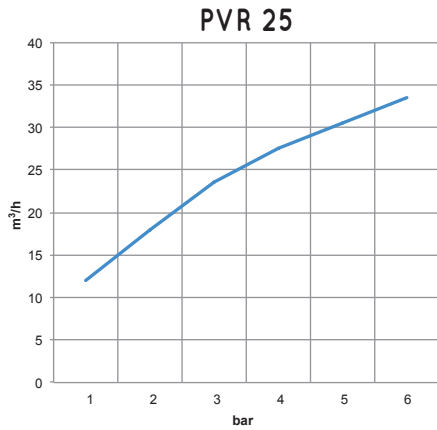

Level of vacuum (-Kpa) at different supply pressures (bar)

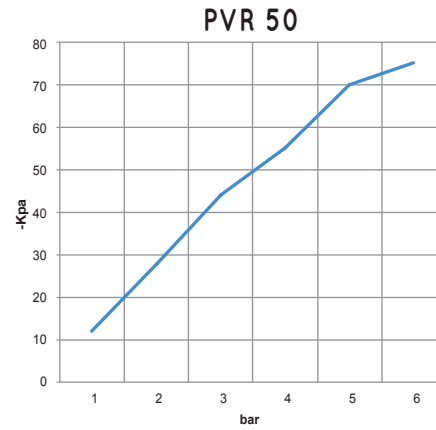
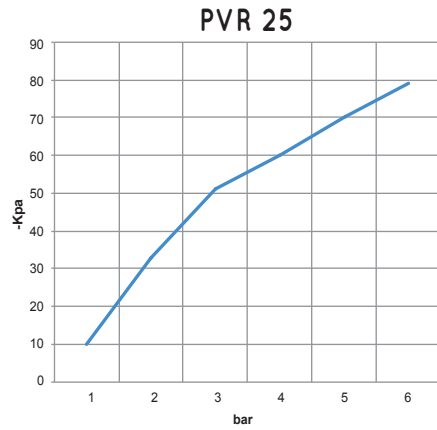

Air consumption (NI/s) at different supply pressures (bar)

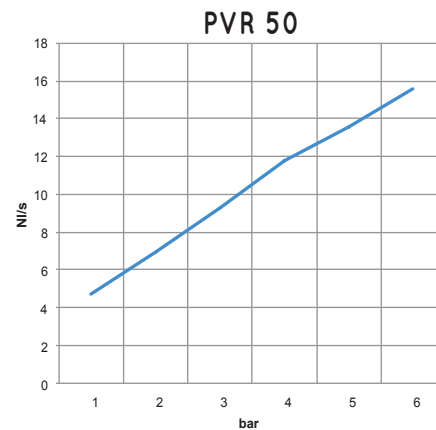
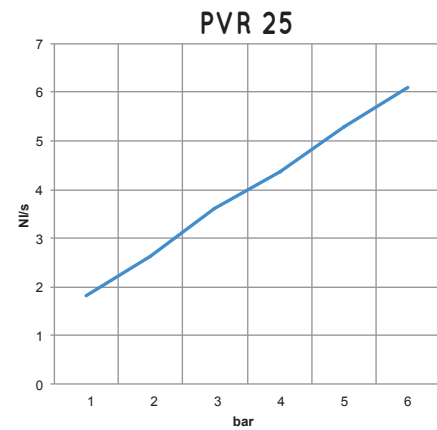

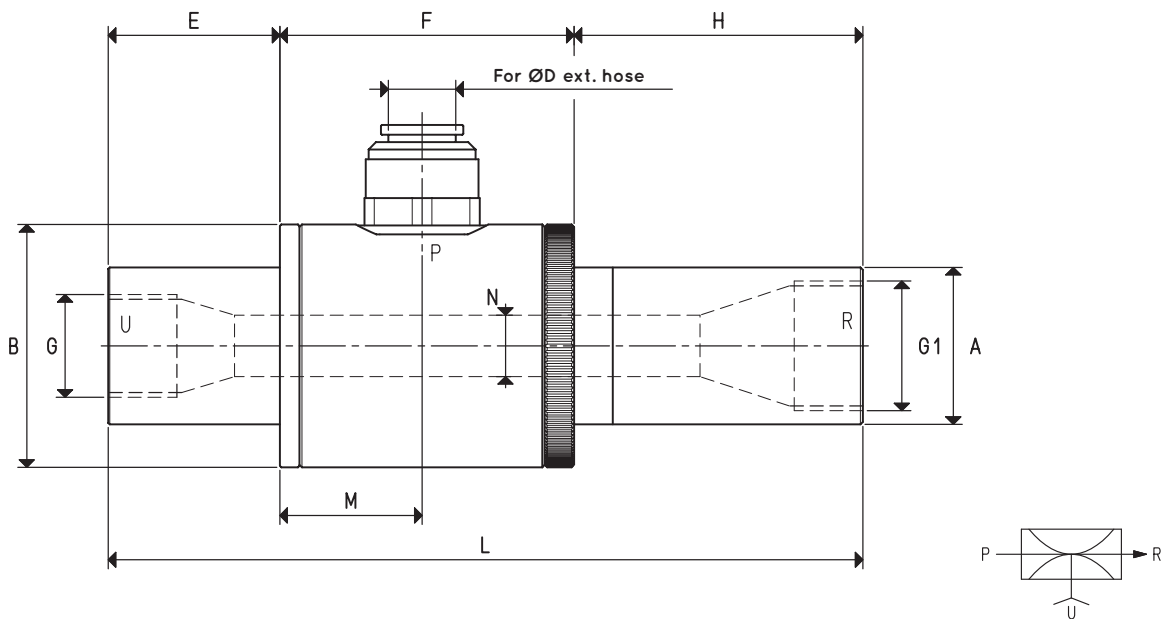

P=COMPRESSED AIR CONNECTION      R=EXHAUST      U=VACUUM CONNECTION

Item		PVR 100	PVR 200
Max quantity of intake air at 5 bar	m <sup>3</sup> /h	50	72
Max quantity of air blown at 6 bar	m <sup>3</sup> /h	129	177
Maximum level of vacuum	-KPa	75	70
Final pressure	abs. mbar	250	300
Maximum supply pressure	bar	6	6
Maximum air consumption at 6 bar	NI/s	22.7	28.3
Temperature of use	°C	-20 / +80	-20 / +80
Noise level	dB(A)	100	104
Weight	g	430	550
A	∅	32	38
B	∅	50	57
D	∅	10	12
E		35	35
F		60	60
G	∅	G1/2"	G3/4"
G 1	∅	G3/4"	G1"
H		55	77
L		150	172
M		28	28
N	∅	12.5	16.0

Note: All vacuum values indicated in the table are valid at the normal atmospheric pressure of 1013 mbar and obtained with a constant supply pressure.

Add the letter I, to the item for a generator supplied in stainless steel (Example: PVR 100 I).

Vacuum generator supply must be carried out with non-lubricated compressed air, 5 micron filtration, in accordance with standard ISO 8573-1 class 4.



# ADJUSTABLE CONVEYOR VACUUM GENERATORS PVR 100 and PVR 200

Quantity of air suctioned ( $m^3/h$ ) at different supply pressures (bar)

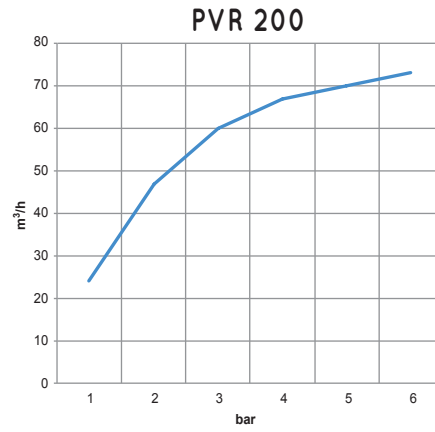
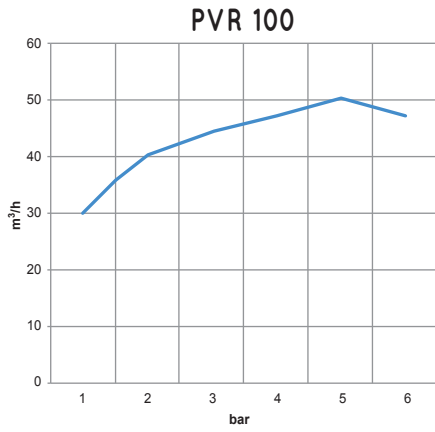

Quantity of air blown ( $m^3/h$ ) at different supply pressures (bar)

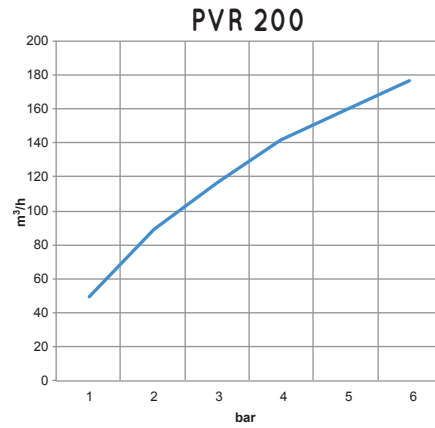
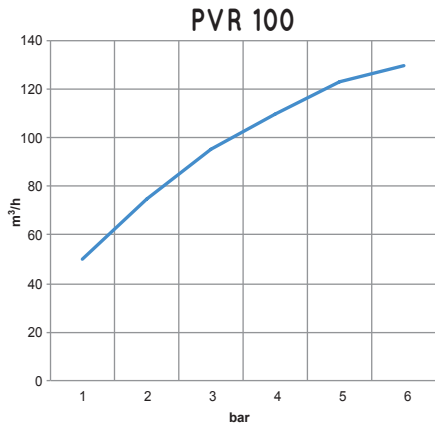

Level of vacuum (-Kpa) at different supply pressures (bar)

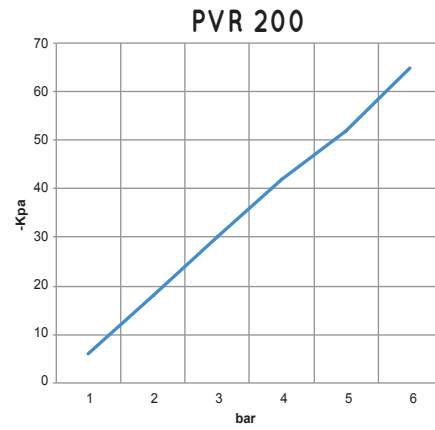
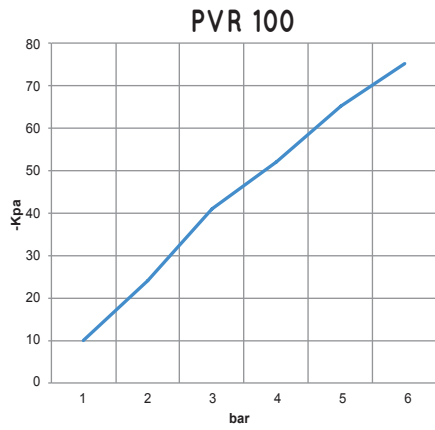

Air consumption (NI/s) at different supply pressures (bar)

